

# Ignis Gesture<sup>®</sup>



Bryant Dental Product

A pair of dark-rimmed glasses is centered in the upper half of the frame. A bright, conical beam of light originates from the bridge of the glasses and extends downwards, illuminating the text below. The background is solid black.

**Illumination, reimagined.**

# Contents.

- 04. The BD story
- 07. The **Ignis Gesture** story
- 08. Intended use
- 10. Safety instructions
- 12. Components
- 14. Charging and before use
- 15. How to use
- 16. Cleaning and maintenance
- 17. Disposal
- 18. Servicing and troubleshooting
- 19. Get in touch
- 20. Warranty
- 21. Technical specifications



The BD story.





Dr Connor Bryant  
CEO and Founder



Dr Priyam Patel  
Co CEO

**Bryant Dental was created by dentists to solve clinical problems they themselves had faced, by using technology in unprecedented ways.**

Since our incorporation, we have grown exponentially, thanks to our community of passionate, talented dentists who believe, like us, that dentistry can be done differently.

Inspired by clinicians who strive for brilliance, we aim to bring the latest innovation and technology to extraordinary dentists to facilitate their pursuit of excellence.

C-Flo | medicar | Ignis | Lucidum | MagStrap™  
Ozmo | Nomic | Refractives | HALO | iShields



# The Ignis Gesture story.

The Ignis Gesture was created to provide an ultra bright headlight, with outstanding optical clarity.

Ultra light and bright, the Ignis Gesture re-imagines surgical and dental illumination whilst making your loupes feel lighter.



# Intended use.

The **Ignis Gesture** Headlight is an illumination device attached to spectacles that is intended to illuminate oral structures and operating areas.

This device is designed to be used by qualified dental professionals, including, but not limited to, dentists and dental hygienists, as well as medical doctors and/or professionals.

**Ignis Gesture** must be used with the bracket, power supply, battery and light provided.



**Follow** instructions for use.



**Do not** look directly into the light output.



**Do not** bring the device within 25cm of the patient.



**Ensure** that filter is fully tightened before use.



**Do not** touch the light when on, it can become very hot and cause burns and other injuries.



**Do not** use with silicone allergy.



**Do not** use if you have a pacemaker.



**Angular** adjustments must only be made when the Ignis Gesture is at room temperature to avoid potential burn.





Thank you for  
choosing Bryant Dental.

We believe in creating excellent products for extraordinary dentists, and we are always proud to gain a new member of our community of passionate clinicians. Join the BD club to see what other members have done with **Ignis Gesture**.

# Safety instructions.

## Conditions

- Use supplied charger, using another charger will damage the battery and invalidate the warranty.
- Do not immerse any of the **Ignis Gesture** system in water.
- If any problems occur with the unit, return to Bryant Dental® for repair. Attempting to repair yourself will void the warranty.
- Do not change or modify any of the existing components without authorisation from Bryant Dental®.
- Do not leave the light on inside a pocket, as it will cause the unit to overheat.
- Do not leave the battery or the headlight on exposed skin, as it can cause burns.
- Do not charge unattended or leave in environments exceeding 40°C.
- If battery behaves abnormally, immediately contact Bryant Dental®.
- Take care not to touch the LED during use, as this can cause a burn injury.
- Do not shine in eyes.
- Do not bring battery or light within 25cm of the patient.
- Ensure that filter is fully tightened before use using enclosed screwdriver.



- Do not use if you have a pacemaker.
- Do not use with silicone allergy.
- Use of loose components carries with it a serious risk of choking.



# Components.

- LED Headlight
- Dichroic composite filter
- Battery unit x2
- Power adapter (country specific)
- Headlight bracket (frame specific)
- **Ignis Gesture** Magstrap
- **Ignis Gesture** screwdriver
- Quick start guide





# Charging and before use.

## 1 Getting started

Place the **Ignis Gesture** batteries onto the charging plate where they will magnetically attach in the correct orientation.

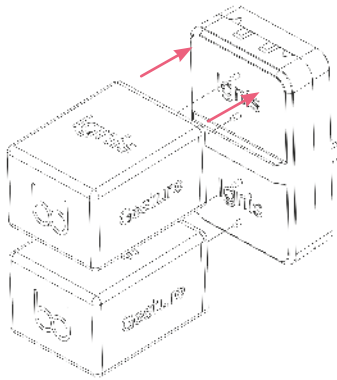

## 2 Switch ON

**Ensure** that the charging plate is plugged into the power supply and the power adapter is plugged into the wall plug and switched on.

## 3 Charging status

There are two LEDs on the charging plate which glow blue when the batteries are charging and glow green when fully charged.

The LED on the left shows the charging status of the top battery, and the right LED indicates the charging status of the bottom battery.

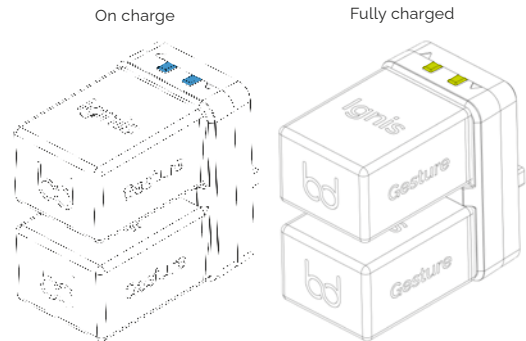





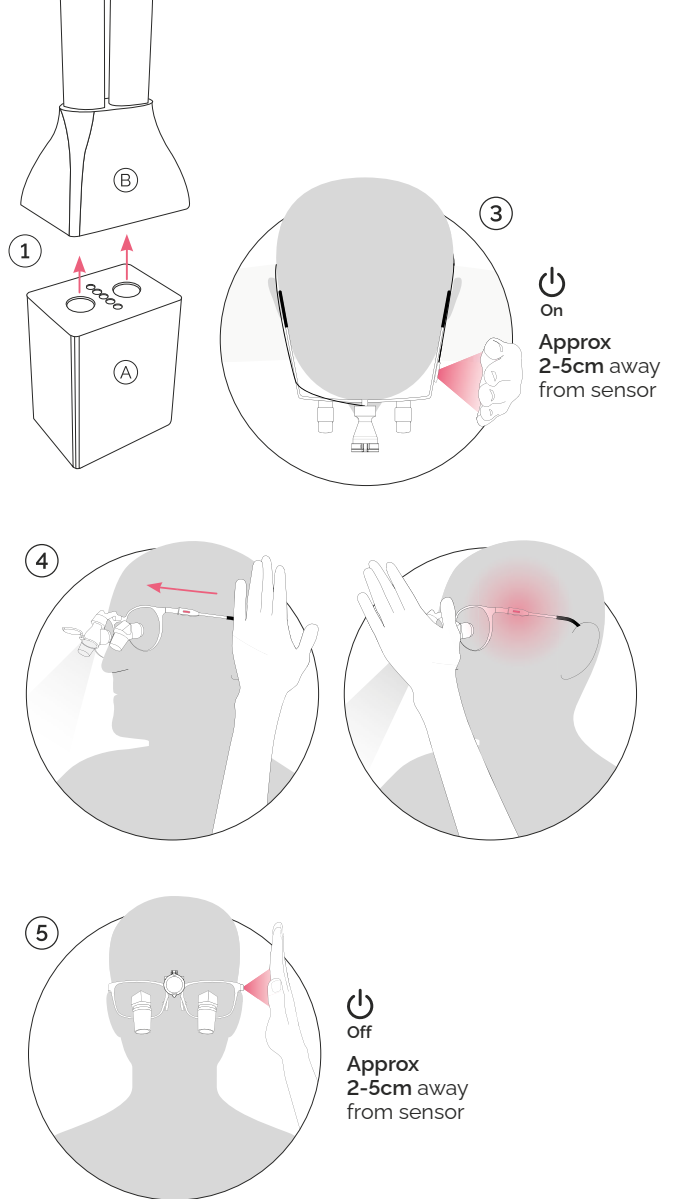

# How to use.

1. Connect the **Ignis Gesture** battery (A) and **Ignis Gesture** MagStrap (B) together.
2. Before switching on the headlight ensure that the light is not pointed at anyone.
3. Bring your hand up to the **IR sensor** window located on the left arm of your loupes for 2-4 seconds to switch on the **Ignis Gesture**.
4. To switch between low and high brightness levels, briefly move your hand past the sensor window.
5. To switch off the **Ignis Gesture** bring your hand up to the sensor window on the left once more until the light turns off.



# Cleaning and maintenance instructions.

-  **Do not** run under water.
-  **Do not** spray the device.
-  **Do not** submerge in any liquid or ultrasonic cleaner.
-  **Do not** use autoclave or chemiclave.
-  **Do not** use glutaraldehyde or idophor.
-  **Do not** use a cleaner with alcohol concentration greater than 70%.





# Disposal.



When you plan to dispose of the device, please return to Bryant Dental® for recycling. The European Union Waste Electrical and Electronic Equipment (WEEE) Directive forbids the disposal of waste electrical and electronic equipment as unsorted municipal waste, requiring that it be collected and recycled or disposed of separately.

Hazardous substances are present in electrical and electronic equipment and present potential risk to human health and the environment if disposed of in municipal and fills, which are not designed to prevent migration of substances into the soil and groundwater.

**Ignis Gesture** battery packs contain Lithium Ion cells. Return to Bryant Medical, recycle or dispose of the batteries according to national, state, and local regulations.

Compliant with RoHS directive 2011/65/EU.



# Servicing and troubleshooting.

- Lithium Ion batteries are considered expendable and will last 300 charge/discharge cycles before gradually losing capacity. New **Ignis Gesture** battery packs can be ordered directly from Bryant Dental® or your local distributor.
- Ensure the **Ignis Gesture** Headlight is regularly cleaned and disinfected.
- Enquire with Bryant Dental® about a service plan for the highest level of support.

<b>Battery is not charging</b>	Switch the mains power off and then on whilst the batteries are attached to the charging plate to reset the batteries.  If this doesn't solve the issue, please contact Bryant Dental®.
<b>Ignis Gesture® is not switching on</b>	Run through userguide to ensure correct operation. Run through troubleshooting guides.  If unsuccessful, contact Bryant Dental®.
<b>Light comes on intermittently</b>	Ensure <b>Ignis Gesture</b> battery pack has charge. Ensure all connections are clean. Ensure wires are not twisted.
<b>Light is flickering</b>	Ensure <b>Ignis Gesture</b> battery pack has charge. Ensure all connections are clean. Ensure wires are not twisted.
<b>There is no light output</b>	Ensure all connections are clean. Ensure wires are not twisted.
<b>Battery is behaving abnormally</b>	If the battery exhibits abnormal function please cease use immediately and contact Bryant Dental®. Abnormal function could include, though is not limited to, overheating, expanding or changing shape.

# Get in touch.

If you have any questions or concerns, please don't hesitate to get in touch.



Scan to connect

Our 24/7 support team is always on hand if you need anything. In the first instance please contact your product specialist or local distributor, you can find their contact details on the support page of the website at [www.bryant.dental/support](http://www.bryant.dental/support)

Our office team are also available to answer any questions you may have.

**UK office contact number:**

 +44 (0)1932 320064

 +44 (0)7990 113723

**UK office address:**

Bryant Dental, Hilltop Farm, Lyne Lane, Chertsey, KT16 0AW, United Kingdom

---

**Australian office contact number:**

 +61(2)72089592

**Australian Office Address:**

Bryant Dental, Suite 12, 13U/175 Lower Gibbes St Roseville NSW 2069, Australia

# Warranty.

Bryant Dental® will repair any **Ignis Gesture** issue arising from a manufacturing defect for a period of two years, without charge. The liability will not exceed the amount you originally paid for the product.

The warranty does not cover defects arising from negligence, product modification, unauthorised repairs, accidental damage, theft, loss or acts of God.

SN

See Product

GTIN

5060678494322

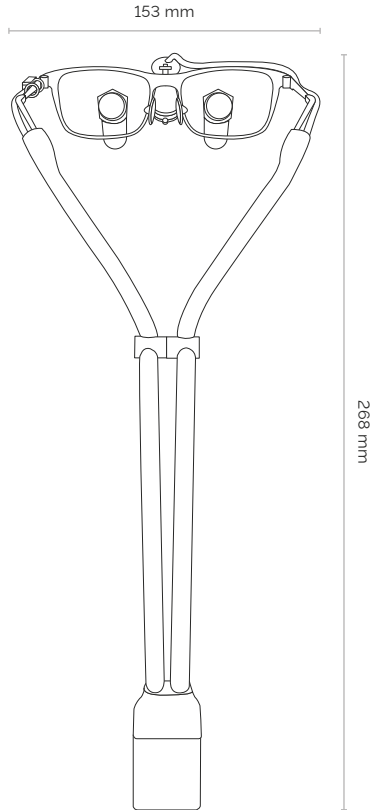

# Technical specifications.

## Dimensions

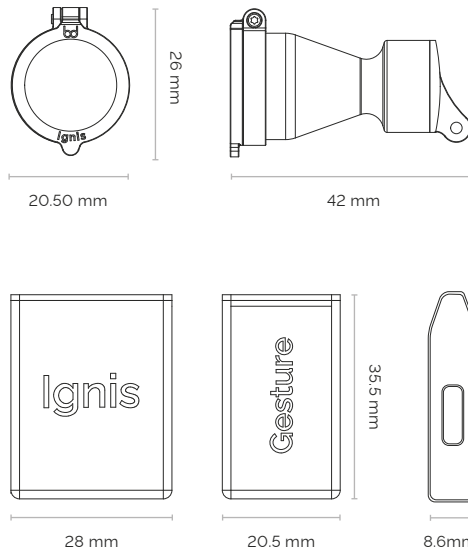

### In the box

- Ignis LED Headlight with integrated headstrap
- Dichroic wavelength filter
- x2 Ignis Gesture batteries
- Battery charging dock
- Ignis USB wall plug (country specific)
- Ignis screw driver
- Ignis bracket
- Quick start guide
- Instruction manual can be downloaded

Technical:

Model	A-494322, B-494322
SKU	5060678494322
Spot size (A-490430)	10cm diameter @ 40cm Working Distance
Spot size (B-490430)	7cm diameter @ 40cm Working Distance
Beam colour temperature	5700K
Beam intensity	36 – 90 lumens
Battery weight (Circa)	33g each
System weight (Circa exc. batteries)	62g
Battery operating power	DC3.8V $\bar{\text{---}}$ 450mA @4.71Wh
Charger input	AC100 - 240 volts, 50-60 Hz, max. 0.8A
Charger output	5.0V 2A 10W
Operating time (constant output)	2 – 5 hours
Battery charge/discharge cycle count	>300

Only use supplied charging adapter

Storage and shipping conditions:

Storage temperature	0°C - 40°C
Relative humidity	30 - 75%

Environmental operating conditions:

Operating temperature	0° - 30°C
Charging temperature	10° - 30°C
Relative humidity	30 - 75%
Atmospheric pressure	70.0 kPa to 106.0 kPa

**Parts list: of full system:**

Part name	Part code
Ignis Gesture LED	A-495404
Dichroic composite filter	A-495213
Ignis Gesture battery	A-494919
Ignis Gesture charging plate	A-494933
Power adapter (country specific)	A-490058
Headlight brackets (frame specific)	A-494476, A-494483
Green BD screwdriver	A-494667
Black BD screwdriver	A-492182
Quick Guide	A-495299

All parts supplied by Bryant Medical

**Applicable standards:**

EN60601-1:2006 + A1:2013
EN60601-1-2:2015 + A1:2021
IEC60601-1-6:2010 + A1:2013 + A2:2020
IEC60601-1-2:2014 + A1:2020
EN60601-1:2006 + A12:2014
IEC62471:2006 (risk group 2)

**Meets requirements of the EU-MDR**

**Contraindications:**

Silicone allergy
Do not use if you have a pacemaker



This device contains magnets which should not be used if you have a pacemaker, or with patients with pacemakers.



Follow instructions for use



Operating temperature limit



This device is not sterile



Do not dispose



Do not use if package is damaged



Keep the device a minimum distance of 25cm from the patient



Do not use if you have a silicone rubber allergy



Do not expose batteries to naked flame



Possible hazardous optical radiation emitted from this product. Do not stare at the operating lamp. May be harmful to your eyes - Risk group 2



Bryant Medical Ltd,  
The Barns, Hilltop Farm,  
Lyne Lane, Chertsey,  
KT16 0AW, U.K



Meets requirements of MDR





Ensure filter is fully tightened using enclosed screwdriver



Use of loose components carries with it a serious risk of choking

[www.bryant.dental](http://www.bryant.dental)

 UK +44 (0)1932 320064 | AUS +61 (02) 72089592

 UK +44 (0)7990 113723

Bryant Medical, The Barns, Hilltop Farm, Lyne Lane, Chertsey, KT16 0AW, UK  
Bryant Medical Ltd UK are registered trademarks in the United Kingdom and Australia.



**Bryant Dental**

Dentistry, reimagined.

Registered in England & Wales No. 10396020. Registered in Australia No. 634 752 980

BR15/EN1.0/IGG/IFU Rev 2.1 Sept 2023